



European Technical Approval ETA-04/0072

English translation prepared by DIBt - Original version in German language

Handelsbezeichnung <i>Trade name</i>	KALM Verbundmörtel VMK-SF KALM Injection Mortar VMK-SF
Zulassungsinhaber <i>Holder of approval</i>	KALM Befestigungssysteme GmbH Marie-Curie-Straße 5 67661 Kaiserslautern DEUTSCHLAND
Zulassungsgegenstand und Verwendungszweck <i>Generic type and use of construction product</i>	Verbunddübel (Injektionssystem) mit Ankerstange in den Größen M10, M12 und M16 zur Verankerung im ungerissenen Beton <i>Bonded anchor (injection type) with anchor rod of sizes M10, M12 and M16 for use in non-cracked concrete</i>
Geltungsdauer: <i>Validity:</i>	vom <i>from</i> 10 August 2011 bis <i>to</i> 24 August 2014
Herstellwerk <i>Manufacturing plant</i>	KALM Befestigungssysteme GmbH Marie-Curie-Straße 5 67661 Kaiserslautern

Diese Zulassung umfasst
This Approval contains

13 Seiten einschließlich 5 Anhänge
13 pages including 5 annexes

Diese Zulassung ersetzt
This Approval replaces

ETA-04/0072 mit Geltungsdauer vom 24.08.2009 bis 24.08.2014
ETA-04/0072 with validity from 24.08.2009 to 24.08.2014

I LEGAL BASES AND GENERAL CONDITIONS

- 1 This European technical approval is issued by Deutsches Institut für Bautechnik in accordance with:
 - Council Directive 89/106/EEC of 21 December 1988 on the approximation of laws, regulations and administrative provisions of Member States relating to construction products¹, modified by Council Directive 93/68/EEC² and Regulation (EC) N° 1882/2003 of the European Parliament and of the Council³;
 - Gesetz über das In-Verkehr-Bringen von und den freien Warenverkehr mit Bauprodukten zur Umsetzung der Richtlinie 89/106/EWG des Rates vom 21. Dezember 1988 zur Angleichung der Rechts- und Verwaltungsvorschriften der Mitgliedstaaten über Bauprodukte und anderer Rechtsakte der Europäischen Gemeinschaften (Bauproduktengesetz - BauPG) vom 28. April 1998⁴, as amended by law of 31 October 2006⁵;
 - Common Procedural Rules for Requesting, Preparing and the Granting of European technical approvals set out in the Annex to Commission Decision 94/23/EC⁶;
 - Guideline for European technical approval of "Metal anchors for use in concrete - Part 5: Bonded anchors", ETAG 001-05.
- 2 Deutsches Institut für Bautechnik is authorized to check whether the provisions of this European technical approval are met. Checking may take place in the manufacturing plant. Nevertheless, the responsibility for the conformity of the products to the European technical approval and for their fitness for the intended use remains with the holder of the European technical approval.
- 3 This European technical approval is not to be transferred to manufacturers or agents of manufacturers other than those indicated on page 1, or manufacturing plants other than those indicated on page 1 of this European technical approval.
- 4 This European technical approval may be withdrawn by Deutsches Institut für Bautechnik, in particular pursuant to information by the Commission according to Article 5(1) of Council Directive 89/106/EEC.
- 5 Reproduction of this European technical approval including transmission by electronic means shall be in full. However, partial reproduction can be made with the written consent of Deutsches Institut für Bautechnik. In this case partial reproduction has to be designated as such. Texts and drawings of advertising brochures shall not contradict or misuse the European technical approval.
- 6 The European technical approval is issued by the approval body in its official language. This version corresponds fully to the version circulated within EOTA. Translations into other languages have to be designated as such.

¹ Official Journal of the European Communities L 40, 11 February 1989, p. 12
² Official Journal of the European Communities L 220, 30 August 1993, p. 1
³ Official Journal of the European Union L 284, 31 October 2003, p. 25
⁴ *Bundesgesetzblatt Teil I 1998*, p. 812
⁵ *Bundesgesetzblatt Teil I 2006*, p. 2407, 2416
⁶ Official Journal of the European Communities L 17, 20 January 1994, p. 34

II SPECIFIC CONDITIONS OF THE EUROPEAN TECHNICAL APPROVAL

1 Definition of product and intended use

1.1 Definition of product

The KALM Injection Mortar VMK-SF with anchor rod is a bonded anchor (injection type) consisting of a mortar cartridge, an anchor rod with hexagon nut and washer in the range of M10, M12 and M16. The anchor rod (including nut and washer) are made of galvanised steel, stainless steel respectively high corrosion resistant steel. The anchor rod is placed into a drilled hole filled with injection mortar and is anchored via the bond between anchor rod, injection mortar and concrete. For the installed anchor see Figure given in Annex 1.

1.2 Intended use

The anchor is intended to be used for anchorages for which requirements for mechanical resistance and stability and safety in use in the sense of the Essential Requirements 1 and 4 of Council Directive 89/106 EEC shall be fulfilled and failure of anchorages made with these products would cause risk to human life and/or lead to considerable economic consequences. Safety in case of fire (Essential Requirement 2) is not covered in this ETA. The anchor is to be used only for anchorages subject to static or quasi-static loading in reinforced or unreinforced normal weight concrete of strength classes C20/25 at minimum and C50/60 at most according to EN 206:2000-12. It may be anchored in non-cracked concrete only.

Bonded anchor made of galvanised steel:

The element made of galvanised steel may only be used in structures subject to dry internal conditions.

Bonded anchor made of stainless steel 1.4401, 1.4404, 1.4571, 1.4578:

The element made of stainless steel may be used in structures subject to dry internal conditions and also in structures subject to external atmospheric exposure (including industrial and marine environment), or exposure in permanently damp internal conditions, if no particular aggressive conditions exist. Such particular aggressive conditions are e.g. permanent, alternating immersion in seawater or the splash zone of seawater, chloride atmosphere of indoor swimming pools or atmosphere with extreme chemical pollution (e.g. in desulphurization plants or road tunnels where de-icing materials are used).

Bonded anchor made of high corrosion resistant steel 1.4529, 1.4565:

The element made of high corrosion resistant steel may be used in structures subject to dry internal conditions and also in structures subject to external atmospheric exposure, in permanently damp internal conditions or in other particular aggressive conditions. Such particular aggressive conditions are e.g. permanent, alternating immersion in seawater or the splash zone of seawater, chloride atmosphere of indoor swimming pools or atmosphere with chemical pollution (e.g. in desulphurization plants or road tunnels where de-icing materials are used).

The anchor may be installed in dry or wet concrete, it must not be installed in flooded holes. Overhead installation is not admissible.

The anchor may be used in the following temperature range:

Temperature range: -40 °C to +80 °C (max short term temperature +80 °C and
max long term temperature +50 °C)

The provisions made in this European Technical Approval are based on an assumed intended working life of the anchor of 50 years. The indications given on the working life cannot be interpreted as a guarantee given by the producer, but are to be regarded only as a means for choosing the right products in relation to the expected economically reasonable working life of the works.

2 Characteristics of product and methods of verification

2.1 Characteristics of product

The anchor corresponds to the drawings and provisions given in Annexes 1 and 2. The characteristic material values, dimensions and tolerances of the anchor not indicated in Annexes 1 and 2 shall correspond to the respective values laid down in the technical documentation⁷ of this European Technical Approval.

The characteristic anchor values for the design of anchorages are given in Annex 5.

Each anchor rod shall be marked with the identifying mark of the producer and the anchor size according to Annex 1. In addition each anchor made of stainless steel 1.4401, 1.4404, 1.4571 or 1.4578 is marked with the letter "E". In addition each anchor made of high corrosion resistant steel 1.4529 or 1.4565 is marked with the letter "H". Each mortar cartridge shall be marked with the identifying mark of the producer and with the trade name.

The two components of the injection mortar are delivered in unmixed condition in mortar cartridges of 150 ml, 235 ml, 280 ml, 300 ml, 345 ml, 380 ml or 825 ml according to Annex 3.

2.2 Methods of verification

The assessment of fitness of the anchor for the intended use in relation to the requirements for mechanical resistance and stability and safety in use in the sense of the Essential Requirements 1 and 4 has been made in accordance with the "Guideline for European Technical Approval of Metal Anchors for Use in Concrete", Part 1 "Anchors in general" and Part 5 "Bonded anchors", on the basis of Option 12.

In addition to the specific clauses relating to dangerous substances contained in this European Technical Approval, there may be other requirements applicable to the products falling within its scope (e.g. transposed European legislation and national laws, regulations and administrative provisions). In order to meet the provisions of the EU Construction Products Directive, these requirements need also to be complied with, when and where they apply.

⁷

The technical documentation of this European Technical Approval is deposited at the Deutsches Institut für Bautechnik and, as far as relevant for the tasks of the approved bodies involved in the attestation of conformity procedure, is handed over to the approved bodies.

3 Evaluation of Conformity and CE marking

3.1 Attestation of Conformity system

According to the Decision 96/582/EG of the European Commission⁸ system 2(i) (referred to as System 1) of the attestation of conformity applies.

This system of attestation of conformity is defined as follows:

System 1: Certification of the conformity of the product by an approved certification body on the basis of:

(a) Tasks for the manufacturer:

- (1) factory production control;
- (2) further testing of samples taken at the factory by the manufacturer in accordance with a prescribed test plan;

(b) Tasks for the approved body:

- (3) initial type-testing of the product;
- (4) initial inspection of factory and of factory production control;
- (5) continuous surveillance, assessment and approval of factory production control.

Note: Approved bodies are also referred to as "notified bodies".

3.2 Responsibilities

3.2.1 Tasks of the manufacturer

3.2.1.1 Factory production control

The manufacturer shall exercise permanent internal control of production. All the elements, requirements and provisions adopted by the manufacturer shall be documented in a systematic manner in the form of written policies and procedures, including records of results performed. This production control system shall insure that the product is in conformity with this European technical approval.

The manufacturer may only use initial/raw/constituent materials stated in the technical documentation of this European technical approval.

The factory production control shall be in accordance with the control plan of August 2009 relating which is part of the technical documentation of this European technical approval. The control plan is laid down in the context of the factory production control system operated by the manufacturer and deposited with Deutsches Institut für Bautechnik.⁹

The results of factory production control shall be recorded and evaluated in accordance with the provisions of the control plan.

3.2.1.2 Other tasks for the manufacturer

The manufacturer shall, on the basis of a contract, involve a body which is approved for the tasks referred to in section 3.1 in the field of anchors in order to undertake the actions laid down in section 3.2.2 For this purpose, the control plan referred to in sections 3.2.1.1 and 3.2.2 shall be handed over by the manufacturer to the approved body involved.

The manufacturer shall make a declaration of conformity, stating that the construction product is in conformity with the provisions of this European technical approval.

⁸ Official Journal of the European Communities L 254 of 08.10.1996

⁹ The control plan is a confidential part of the European technical approval and only handed over to the approved body involved in the procedure of attestation of conformity. See section 3.2.2.

3.2.2 Tasks of approved bodies

The approved body shall perform the

- initial type-testing of the product,
- initial inspection of factory and of factory production control,
- continuous surveillance, assessment and approval of factory production control,

in accordance with the provisions laid down in the control plan.

The approved body shall retain the essential points of its actions referred to above and state the results obtained and conclusions drawn in a written report.

The approved certification body involved by the manufacturer shall issue an EC certificate of conformity of the product stating the conformity with the provisions of this European technical approval.

In cases where the provisions of the European technical approval and its control plan are no longer fulfilled the certification body shall withdraw the certificate of conformity and inform Deutsches Institut für Bautechnik without delay.

3.3 CE marking

The CE marking shall be affixed on each packaging of the anchor. The letters "CE" shall be followed by the identification number of the approved certification body, where relevant, and be accompanied by the following additional information:

- the name and address of the producer (legal entity responsible for the manufacture),
- the last two digits of the year in which the CE marking was affixed,
- the number of the EC certificate of conformity for the product,
- the number of the European technical approval,
- the number of the guideline for European technical approval
- use category (ETAG 001-1, Option 12)
- size

4 Assumptions under which the fitness of the product for the intended use was favourably assessed

4.1 Manufacturing

The European technical approval is issued for the product on the basis of agreed data/information, deposited with Deutsches Institut für Bautechnik, which identifies the product that has been assessed and judged. Changes to the product or production process, which could result in this deposited data/information being incorrect, should be notified to Deutsches Institut für Bautechnik before the changes are introduced. Deutsches Institut für Bautechnik will decide whether or not such changes affect the approval and consequently the validity of the CE marking on the basis of the approval and if so whether further assessment or alterations to the approval shall be necessary.

4.2 Installation

4.2.1 Design of anchorages

The fitness of the anchor for the intended use is given under the following conditions:

The anchorages are designed in accordance with the "Guideline for European Technical Approval of Metal Anchors for Use in Concrete", Annex C, Method C, for bonded anchors under the responsibility of an engineer experienced in anchorages and concrete work.

Verifiable calculation notes and drawings are prepared taking account of the loads to be anchored.

The position of the anchor is indicated on the design drawings (e.g. position of the anchor relative to reinforcement or to supports, etc.).

4.2.2 Installation of anchors

The fitness for use of the anchor can only be assumed if the anchor is installed as follows:

- anchor installation carried out by appropriately qualified personnel and under the supervision of the person responsible for technical matters of the site,
- use of the anchor only as supplied by the manufacturer without exchanging the components of an anchor,
- commercial standard threaded rods, washers and hexagon nuts may be used if the following requirements are fulfilled:
 - material, dimensions and mechanical properties of the metal parts according to the specifications given in Annex 2,
 - confirmation of material and mechanical properties of the metal parts by inspection certificate 3.1 according to EN 10204:2004, the documents should be stored,
 - marking of the threaded rod with the envisage embedment depth. This may be done by the manufacturer of the rod or the person on jobsite.
- anchor installation in accordance with the manufacturer's specifications and drawings using the tools indicated in the technical documentation of this European technical approval,
- checks before placing the anchor to ensure that the strength class of the concrete in which the anchor is to be placed is in the range given and is not lower than that of the concrete to which the characteristic loads apply,
- check of concrete being well compacted, e.g. without significant voids,
- no overhead installation,
- keeping of the effective anchorage depth,
- keeping of the edge distance and spacing to the specified values without minus tolerances,
- positioning of the drill holes without damaging the reinforcement,
- drilling by hammer-drilling or compressed air drilling,
- in case of aborted hole: The hole shall be filled with mortar,
- the anchor must not be installed in flooded holes,
- cleaning drill hole and anchor installation in accordance with manufacturers installation instructions (Annex 4),
- during installation and curing of the chemical mortar the anchor component installation temperature shall be at least 0 °C; the temperature; observing the curing time according to Annex 5, Table 4 until the anchor may be loaded,
- anchor rods (including nut and washer) must be made of appropriate steel grade and property class according to Annex 2, Table 2,
- installation torque moments are not required for functioning of the anchor. However, the torque moments given in Annex 4, Table 3 must not be exceeded.

5 Indications to the manufacturer

5.1 Responsibility of the manufacturer

The manufacturer is responsible to ensure that the information on the specific conditions according to 1 and 2 including Annexes referred to and 4.2.1 and 4.2.2 is given to those who are concerned. This information may be made by reproduction of the respective parts of the European technical approval.

In addition all installation data shall be shown clearly on the package and/or on an enclosed instruction sheet, preferably using illustration(s).

The minimum data required are:

- drill bit diameter,
- hole depth,
- diameter of anchor rod,
- minimum effective anchorage depth,
- maximum thickness of the fixture
- information on the installation procedure, including cleaning of the hole with the cleaning equipments, preferably by means of an illustration,
- anchor component installation temperature,
- ambient temperature of the concrete during installation of the anchor,
- admissible processing time (open time) of the mortar,
- curing time until the anchor may be loaded as a function of the ambient temperature in the concrete during installation,
- maximum torque moment,
- identification of the manufacturing batch,

All data shall be presented in a clear and explicit form.

5.2 Packaging, transport and storage

The injection cartridges shall be protected against sun radiation and shall be stored according to the manufacturer's installation instructions in dry condition at temperatures of at least +5 °C to not more than +25 °C.

Mortar cartridges with expired shelf life must no longer be used.

The anchor shall only be packaged and supplied as a complete unit. Cartridges may be packed separately from metal parts.

The manufacture's installation instruction shall indicate that the KALM Injection Mortar VMK-SF can be used only with the corresponding anchor rods of the manufacturer.

Georg Feistel
Head of Department

beglaubigt:
Bürger

Anchor rod

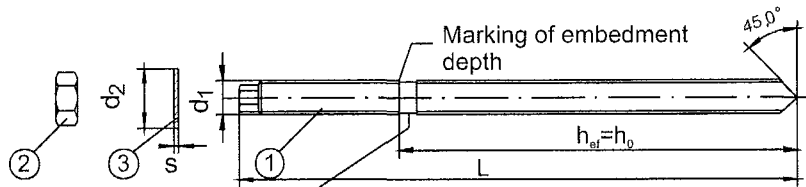

Marking

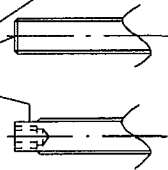

Marking: Identifying mark of manufacturer K
 Thread size M...
 for example KM10,
 for stainless steel additional E,
 for high corrosion resistant additional H

Static mixer

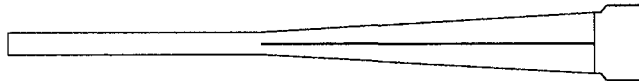

Mortar cartridge & sealing cap

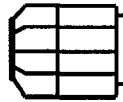

Imprint:
 KALM VMK-SF 380,
 processing notes, shelf-life, hazard-code,
 curing time, processing time (depending
 on temperature)

Intended use

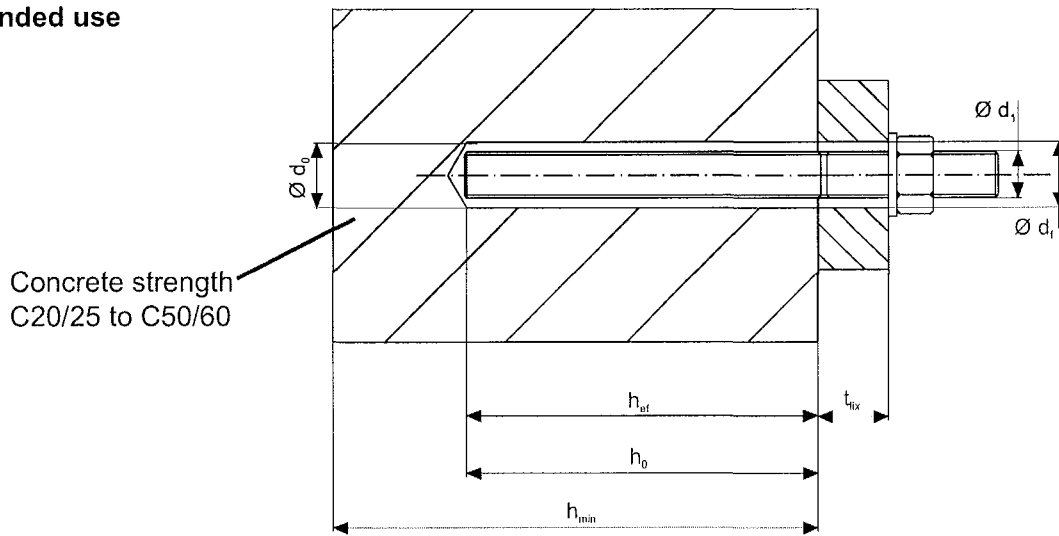

Use category 1: Installation in dry or wet concrete
 Service condition in dry or wet concrete
 - No overhead installation

Temperature range: -40°C to +80°C (max. short term temperature +80°C and
 max. long term temperature +50°C)

KALM injection mortar VMK-SF with anchor rod

Product and Intended use

Annex 1
 of the European
 technical approval
 ETA-04/0072

Table 1 Dimensions

Anchor size		M10	M12	M16
Diameter of the anchor rod	$\varnothing d_1$ [mm]	10	12	16
Length of the anchor rod	$L \geq$ [mm]	130	160	165
Effective anchorage depth	h_{ef} [mm]	90	110	125

Table 2 Materials

Part	Designation	Material
1	Anchor rod	Steel, zinc plated $\geq 5 \mu\text{m}$ acc. to EN ISO 4042 property class 5.8, acc. to EN ISO 898-1
		Stainless steel, grade 1.4401, 1.4404, 1.4571, 1.4578, EN 10088, property class 70, EN ISO 3506
		High corrosion resistant steel 1.4529, 1.4565, EN 10088, property class 70, EN ISO 3506
2	Hexagon nut EN ISO 4032	Steel, property class 8 acc. to EN 20898-2, zinc plated
		Stainless steel, 1.4401, 1.4404, 1.4571, EN 10088, property class 70, EN ISO 3506
		High corrosion resistant steel 1.4529, 1.4565, EN 10088, property class 70, EN ISO 3506
3	Washer EN ISO 7089 EN ISO 7093 EN ISO 7094	Steel, zinc plated
		Stainless steel, 1.4401, 1.4404, 1.4571, EN 10088
		High corrosion resistant steel 1.4529, 1.4565, EN 10088
4	Chemical Mortar	Additive: quartz sand, Bonding agent: vinylester-resin, styrene free, Hardener: dibenzoyl peroxide

Commercial standard rod with:

- Material, dimensions and mechanical properties acc. Table 1 and 2
- Inspection certificate 3.1 according to EN 10204:2004
- Marking of embedment depth

KALM injection mortar VMK-SF with anchor rod

Dimensions and materials

Annex 2
of the European
technical approval
ETA-04/0072

Mortar cartridge 150 ml

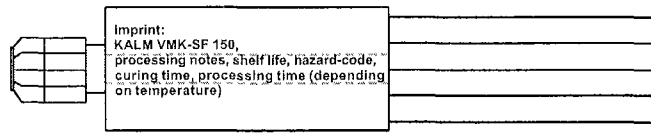

Mortar cartridge 235 ml

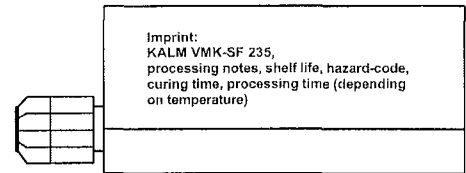

Mortar cartridge 280 ml

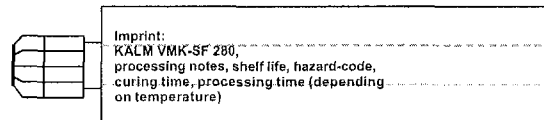

Mortar cartridge 300 ml

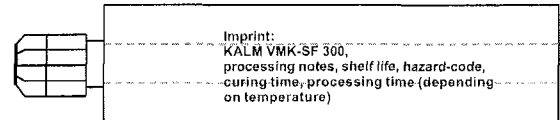

Mortar cartridge 345 ml

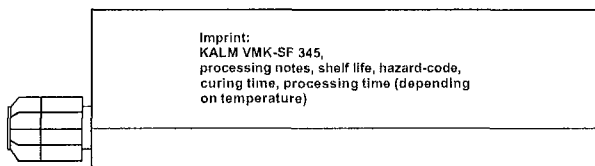

Mortar cartridge 380 ml

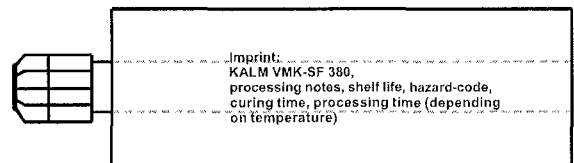

Mortar cartridge 825 ml

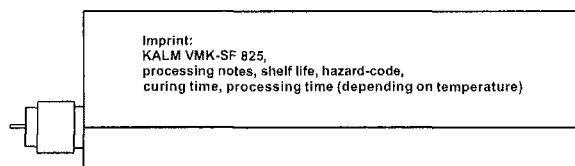

Imprint:

KALM VPK-SF ...
processing notes, shelf-life,
hazard-code, curing time,
processing time (depending
on temperature)

Static mixer SMK

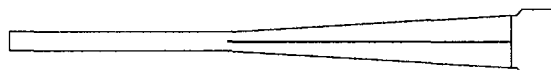

KALM injection mortar VMK-SF with anchor rod

Mortar cartridges and static mixer

Annex 3
of the European
technical approval
ETA-04/0072

Table 3 Installation parameters

Anchor size			M10	M12	M16
Nominal drill bit diameter	d_0	[mm]	12	14	18
Cutting diameter of drill bit	$d_{cut} \leq$	[mm]	12.45	14.5	18.5
Depth of drill hole	$h_0 \geq$	[mm]	90	110	125
Diameter of clearance hole in the fixture	$d_f \leq$	[mm]	12	14	18
Diameter of steel brush	d	[mm]	13	16	20
Maximum installation torque moment	T_{inst}	[Nm]	20	40	60
Maximum thickness of fixture	t_{fix}	[mm]	1400	1380	1360
Minimum edge distance	c_{min}	[mm]	180	220	250
Minimum spacing	s_{min}	[mm]	180	220	250
Minimum thickness of member	h_{min}	[mm]	130	160	160

Steel brush



Installed anchor

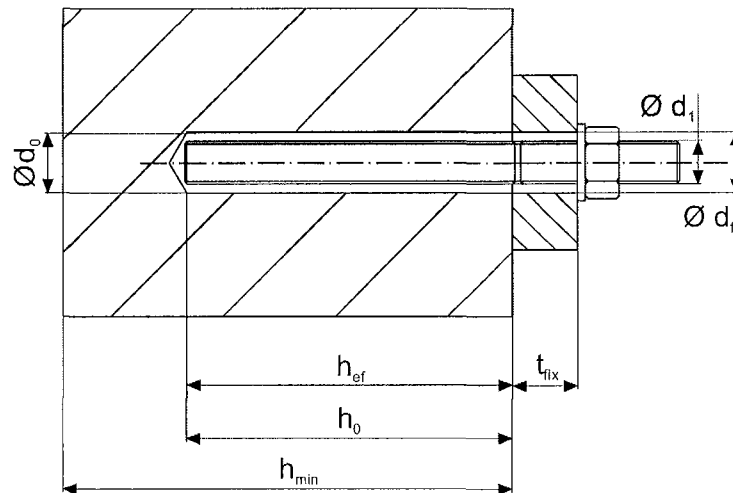

Installation instructions

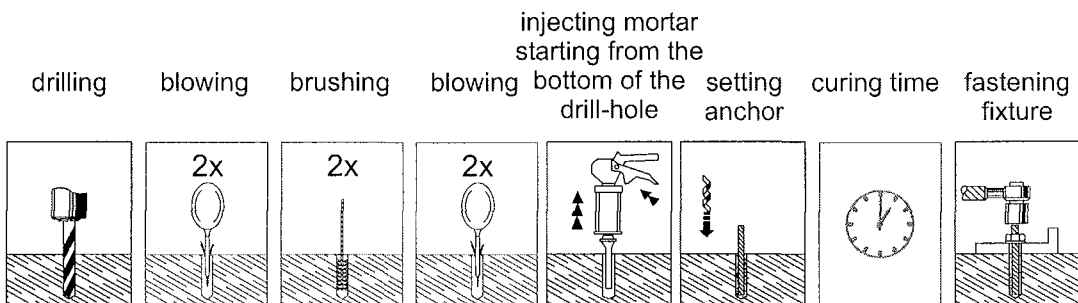

Installation in dry or wet concrete

KALM injection mortar VMK-SF with anchor rod

Installation parameters and installation instructions

Annex 4
of the European
technical approval
ETA-04/0072

Table 4 Minimum curing time

Concrete temperature [°C]	Minimum curing time in dry concrete [min]	Minimum curing time in wet concrete [min]
-5 - 0	360	720
0 - 5	180	360
5 - 20	90	180
20 - 30	45	90
30 - 40	25	50
>40	15	30

Table 5 Design method C, Characteristic values

Anchor size		M10	M12	M16
For all load directions				
Characteristic resistance in C20/25 to C50/60	F_{Rk} [kN]	16	25	30
Partial safety factor	γ_M ¹⁾	2.52	2.16	2.16
Edge distance	c_{cr} [mm]	180	220	250
Spacing	s_{cr} [mm]	180	220	250
Shear loads with lever arm for strength class 5.8				
Characteristic bending moment	$M^0_{Rk,S}$ ²⁾ [Nm]	30	56	133
Partial safety factor	γ_{MS} ¹⁾	1.3	1.3	1.5
Shear loads with lever arm for strength class 70				
Characteristic bending moment	$M^0_{Rk,S}$ ²⁾ [Nm]	40	75	194
Partial safety factor	γ_{MS} ¹⁾	1.56	1.56	1.56

¹⁾ In absence of other national regulations

²⁾ Characteristic bending moment $M^0_{Rk,S}$ for equation (5.5) in ETAG 001, Annex C

Table 6 Displacement of anchors

Anchor size		M10	M12	M16
Load	[kN]	4.5	8.2	10
Displacement under short-term load	δ_0 [mm]	0.9	1.2	0.9
Displacement under long-term load	δ_∞ [mm]	2.0	2.0	2.0

KALM injection mortar VMK-SF with anchor rod

Design method C, Characteristic values
Displacement

Annex 5
of the European
technical approval
ETA-04/0072